

Supplemental Motor Protection Devices Specifications

Bulletin Numbers 809S, 813S, 814S, 817S, 1409, 1410

Topic	Page
Bulletin 809S/813S/814S/817S	2
Product Line Overview	2
Cat. No. Explanation	3
Specifications	4
Standards Compliance and Certifications	7
Function and Wiring Diagrams	8
Approximate Dimensions	14
Bulletin 1409 Arcing Ground Fault Detection System	15
Specifications	15
Standards Compliance and Certifications	15
Typical Wiring Diagrams	16
Approximate Dimensions	17
Bulletin 1410 Motor Winding Heater	18
Specifications	18
Standards Compliance and Certifications	18
Approximate Dimensions	18

Additional Resources





These documents contain additional information concerning related products from Rockwell Automation.

Resource	Description
Industrial Automation Wiring and Grounding Guidelines, publication 1770-4.1	Provides general guidelines for installing a Rockwell Automation industrial system.
Product Certifications website, http://www.ab.com	Provides declarations of conformity, certificates, and other certification details.

You can view or download publications at <http://www.rockwellautomation.com/literature/>. To order paper copies of technical documentation, contact your local Allen-Bradley distributor or Rockwell Automation sales representative.



Product Line Overview

	Bulletin 809S Current Monitoring Relay	Bulletin 813S Voltage Relay		Bulletin 814S Power Factor Relay	Bulletin 814S Power (kW) Relay	Bulletin 817S Thermistor Relay
						
Type	Single-Phase	Single-Phase	Three-Phase	Three-Phase	Three-Phase	—
Operating range	1...10 A AC/DC	2...500V AC/DC	110...115V AC 208...240V AC	1...10 A AC	1...10 A AC	24/48V AC/DC
	24/48V AC/DC	24/48V AC/DC	380...415V AC 440...480V AC	380...480V AC	380...480V AC	115V AC
	115/230V AC	115/230V AC	600...690V AC	600...690V AC	600...690V AC	230V AC
Under- and overcurrent protection	√	—	—	—	—	—
Under- and overvoltage protection	—	√	√	—	—	—
Phase loss protection	—	—	√	—	—	—
Phase imbalance	—	—	√	—	—	—
Phase reversal	—	—	√	—	—	—
Minimum and maximum cos (φ) protection	—	—	—	√	—	—
Under- and over active power (kW) protection	—	—	—	—	√	—
Overtemperature protection	—	—	—	—	—	√
Adjustable time delay settings	√	√	√	√	√	—
Programmable latching or inhibit at set level	√	√	—	√	√	—
Changeover Contacts (SPDT)	1	1	2	1	1	1
Automatic Reset	√	√	√	√	√	—
LED status indicator	√	√	√	√	√	√
Dimensions (W x H x D)	22.5 x 80 x 99.5 mm	22.5 x 80 x 99.5 mm	45 x 80 x 99.5 mm	45 x 80 x 99.5 mm	45 x 80 x 99.5 mm	22.5 x 80 x 99.5 mm

Cat. No. Explanation

Examples given in this section are for reference purposes. This basic explanation should not be used for product selection; not all combinations will produce a valid catalog number.

809S – **C1** – **10A** – **48**
a *b* *c* *d*

<i>a</i>	
Bulletin Number	
Code	Description
809S	Current Monitoring Relay
813S	Voltage Monitoring Relay
814S	Power Monitoring Relay
817S	Thermistor Monitoring Relay

<i>d</i>	
External Power Code	
Code	Description
Bulletin 809S	
48	24/48V AC/DC
230	115/230V AC
Bulletin 813S	
48	24/48V AC/DC (Type V1 only)
230	115/230V AC (Type V1 only)
Bulletin 814S	
—	—
Bulletin 817S	
48	24/48V AC/DC
115	115V AC
230	230V AC

<i>b</i>	
Type	
Code	Description
Bulletin 809S	
C1	Single-Phase Current Monitoring Relay
Bulletin 813S	
V1	Single-Phase Voltage Monitoring Relay
V3	Three-Phase Voltage Monitoring Relay
Bulletin 814S	
W3	Three-Phase Power (kW) Monitoring Relay
PF3	Three-Phase Power Factor Monitoring Relay
Bulletin 817S	
PTC	Thermistor Monitoring Relay

<i>c</i>	
Measurement Rating	
Code	Description
Bulletin 809S	
10A	1...10 A AC/DC
Bulletin 813S	
500V	2...500V AC/DC (Type V1)
110V	110...115V AC (Type V3)
230V	208...240V AC (Type V3)
400V	380...415V AC (Type V3)
480V	440...480V AC (Type V3)
690V	600...690V AC (Type V3)
Bulletin 814S	
480V-10A	380...480V AC & 1...10 A AC
690V-10A	600...690V AC & 1...10 A AC
Bulletin 817S	
—	—

Specifications

Bulletin 809S Current Monitoring Relay, Single-Phase

Cat. No.	809S-C1-10A-48	809S-C1-10A-230
Input Specifications		
Measuring Range	1...10 A AC/DC	1...10 A AC/DC
Internal Resistance	3 mΩ	3 mΩ
Maximum for 1 Second	50 A	50 A
Contact Input	Terminals Z1, Y1	Terminals Z1, Y1
Disabled	>10 kΩ	>10 kΩ
Enabled	<500 Ω	<500 Ω
Latch Disable	>500 ms	>500 ms
Output Specifications		
Type of Contact	(1) Form C	(1) Form C
Rated Insulation Voltage	250V AC	250V AC
Supply Specifications		
	Terminals A1, A2 or A3, A2	Terminals A1, A2 or A3, A2
Rated Operational Voltage	24...48V AC/DC +/- 15%	115/230V AC +/- 15%
	45 to 65 Hz, Insulated	45 to 65 Hz, Insulated
Rated Operational Power	4 VA, 3 W	4 VA, 3 W
General Specifications		
Power ON Delay	1 s +/- 0.5 s or 6 s +/- 0.5 s	1 s +/- 0.5 s or 6 s +/- 0.5 s
Environment		
Degree of Protection	IP 20	IP 20
Pollution Degree	3	3
Dimensions (W x H x D)	22.5 x 80 x 99.5 mm	22.5 x 80 x 99.5 mm
Screw Terminals	Max. 0.5 N•m	Max. 0.5 N•m

Bulletin 813S Voltage Relay, Single-Phase

Cat. No.	813S-V1-500V-48	813S-V1-500V-230
Input Specifications		
Measuring Range	2...500 V AC/DC	2...500 V AC/DC
Internal Resistance	500 kΩ	500 kΩ
Maximum for 1 Second	1000 V	1000 V
Contact Input	Terminals Z1, Y1	Terminals Z1, Y1
Disabled	>10 kΩ	>10 kΩ
Enabled	<500 Ω	<500 Ω
Latch Disable	>500 ms	>500 ms
Output Specifications		
Type of Contact	(1) Form C	(1) Form C
Rated Insulation Voltage	250V AC	250V AC
Supply Specifications		
	Terminals A1, A2 or A3, A2	Terminals A1, A2 or A3, A2
Rated Operational Voltage	24...48V AC/DC +/- 15%	115/230V AC +/- 15%
	45 to 65 Hz, Insulated	45 to 65 Hz, Insulated
Rated Operational Power	4 VA, 3 W	4 VA, 3 W
General Specifications		
Power ON Delay	1 s +/- 0.5 s or 6 s +/- 0.5 s	1 s +/- 0.5 s or 6 s +/- 0.5 s
Environment		
Degree of Protection	IP 20	IP 20
Pollution Degree	3	3
Dimensions (W x H x D)	22.5 x 80 x 99.5 mm	22.5 x 80 x 99.5 mm
Screw Terminals	Max. 0.5 N•m	Max. 0.5 N•m

Bulletin 813S Voltage Relay, Three-Phase

Cat. No.	813S-V3-110V	813S-V3-230V	813S-V3-400V	813S-V3-480V	813S-V3-690V
Input Specifications					
Input	Terminals L1, L2, L3, N	Terminals L1, L2, L3, N	Terminals L1, L2, L3, N	Terminals L1, L2, L3, N	Terminals L1, L2, L3, N
Supply	110...115VAC	208...240VAC	380...415VAC	440...480VAC	600...690VAC
	Self-powered	Self-powered	Self-powered	Self-powered	Self-powered
Frequency	50...400 Hz	50...400 Hz	50...400 Hz	50...400 Hz	50...400 Hz
Ranges					
Upper Level	2...22% of the nominal voltage	2...22% of the nominal voltage	2...22% of the nominal voltage	2...22% of the nominal voltage	2...22% of the nominal voltage
Lower Level	-22...-2% of the nominal voltage	-22...-2% of the nominal voltage	-22...-2% of the nominal voltage	-22...-2% of the nominal voltage	-22...-2% of the nominal voltage
Asymmetry	2...22% of the nominal voltage	2...22% of the nominal voltage	2...22% of the nominal voltage	2...22% of the nominal voltage	2...22% of the nominal voltage
Tolerance	2...22% of the nominal voltage	2...22% of the nominal voltage	2...22% of the nominal voltage	2...22% of the nominal voltage	2...22% of the nominal voltage
Hysteresis					
Set Points from 2...5%	1%	1%	1%	1%	1%
Set Points from 5...22%	2%	2%	2%	2%	2%
Output Specifications					
Type of Contact	(2) Form C, Normally Energized	(2) Form C, Normally Energized	(2) Form C, Normally Energized	(2) Form C, Normally Energized	(2) Form C, Normally Energized
Rated Insulation Voltage	250V AC	250V AC	250V AC	250V AC	250V AC
Supply Specifications					
Rated Operational Power	13 VA @ Δ 400V AC, 50 Hz	13 VA @ Δ 400V AC, 50 Hz	13 VA @ Δ 400V AC, 50 Hz	13 VA @ Δ 400V AC, 50 Hz	21 VA @ Δ 600V AC, 50 Hz
General Specifications					
Power ON Delay	1 s +/- 0.5 s or 6 s +/- 0.5 s	1 s +/- 0.5 s or 6 s +/- 0.5 s	1 s +/- 0.5 s or 6 s +/- 0.5 s	1 s +/- 0.5 s or 6 s +/- 0.5 s	1 s +/- 0.5 s or 6 s +/- 0.5 s
Environment					
Degree of Protection	IP 20	IP 20	IP 20	IP 20	IP 20
Pollution Degree	3	3	3	3	3
Dimensions (W x H x D)	45 x 80 x 99.5 mm	45 x 80 x 99.5 mm	45 x 80 x 99.5 mm	45 x 80 x 99.5 mm	45 x 80 x 99.5 mm
Screw Terminals	Max. 0.5 N•m	Max. 0.5 N•m	Max. 0.5 N•m	Max. 0.5 N•m	Max. 0.5 N•m

Bulletin 814S Power Factor Relay, Three-Phase

Cat. No.	814S-PF3-480V-10A	814S-PF3-690V-10A
Input Specifications		
Input	Terminals L1, L2, L3	Terminals L1, L2, L3
Voltage	380...480V AC, Self-powered	600...690V AC, Self-powered
Current	1...10 A	1...10 A
Measuring Ranges		
Power Factor (cos φ)		
Upper Level	0.1...0.99	0.1...0.99
Lower Level	0.1...0.99	0.1...0.99
Direct Input		
Upper Level	1...10 A	1...10 A
Lower Level	50 A	50 A
Contact Input		
Terminals Z1, Y1		
Enabled / Disabled	<500 Ω / >10 kΩ	<500 Ω / >10 kΩ
Pulse Width	>500 ms	>500 ms
Hysteresis	PF Approx. 0.1	PF Approx. 0.1
Output Specifications		
Type of Contact	(1) Form C	(1) Form C
Rated Insulation Voltage	250V AC	250V AC
Supply Specifications		
Rated Operational Power	13 VA @ Δ400V AC, 50 Hz	21 VA @ Δ600V AC, 50 Hz
General Specifications		
Power ON Delay	1 to 30 s +/- 0.5 s	1 to 30 s +/- 0.5 s
Environment		
Degree of Protection	IP 20	IP 20
Pollution Degree	3	3
Dimensions (W x H x D)	45 x 80 x 99.5 mm	45 x 80 x 99.5 mm
Screw Terminals	Max. 0.5 N·m	Max. 0.5 N·m

Bulletin 814S Power (kW) Relay, Three-Phase

Cat. No.	814S-W3-480V-10A	814S-W3-690V-10A
Input Specifications		
Input	Terminals L1, L2, L3	Terminals L1, L2, L3
Voltage	380...480V AC, Self-powered	600...690V AC, Self-powered
Current	1...10 A	1...10 A
Measuring Ranges		
Active Power		
Upper Level	-100...+100 %	-100...+100 %
Lower Level	-100...+100 %	-100...+100 %
Direct Input		
Upper Level	1...10 A	1...10 A
Lower Level	50 A	50 A
Contact Input		
Terminals Z1, U1		
Enabled / Disabled	<500 Ω / >10 kΩ	<500 Ω / >10 kΩ
Pulse Width	>500 ms	>500 ms
Hysteresis	~2 % of Set Value - Fixed	~2 % of Set Value - Fixed
Output Specifications		
Type of Contact	(1) Form C	(1) Form C
Rated Insulation Voltage	250V AC	250V AC
Supply Specifications		
Rated Operational Power	13 VA @ Δ400V AC, 50 Hz	21 VA @ Δ600V AC, 50 Hz
General Specifications		
Power ON Delay	1 to 30 s +/- 0.5 s	1 to 30 s +/- 0.5 s
Environment		
Degree of Protection	IP 20	IP 20
Pollution Degree	3	3
Dimensions (W x H x D)	45 x 80 x 99.5 mm	45 x 80 x 99.5 mm
Screw Terminals	Max. 0.5 N·m	Max. 0.5 N·m

Bulletin 817S Thermistor Relay

Cat. No.	817S-PTC-48	817S-PTC-115	817S-PTC-230
Input Specifications			
Input	Terminals T1, T2	Terminals T1, T2	Terminals T1, T2
Supply	24...48V AC/DC	115V AC	230V AC
Measuring Ranges			
Max Cold PTC Resistance	1500 Ω	1500 Ω	1500 Ω
Alarm Setpoint	3100 Ω +/- 10 %	3100 Ω +/- 10 %	3100 Ω +/- 10 %
Return Setpoint	1650 Ω +/- 10 %	1650 Ω +/- 10 %	1650 Ω +/- 10 %
Short-circuit Detection	0...10 Ω	0...10 Ω	0...10 Ω
Measurement Voltage	<2.5 V	<2.5 V	<2.5 V
Contact Input			
Disabled	>10 k Ω	>10 k Ω	>10 k Ω
Enabled	<500 Ω	<500 Ω	<500 Ω
Alarm Reset	>500 ms	>500 ms	>500 ms
Output Specifications			
Type of Contact	(1) Form C	(1) Form C	(1) Form C
Rated Insulation Voltage	250V AC	250V AC	250V AC
Supply Specifications			
Rated Operational Power			
AC	2.5VA	2.5VA	2.5VA
DC	1.5 W	1.5 W	1.5 W
General Specifications			
Alarm ON Delay	<150 ms	<150 ms	<150 ms
Reset Delay	<500 ms	<500 ms	<500 ms
Environment			
Degree of Protection	IP 20	IP 20	IP 20
Pollution Degree	3	3	3
Dimensions (W x H x D)	22.5 x 80 x 99.5 mm	22.5 x 80 x 99.5 mm	22.5 x 80 x 99.5 mm
Screw Terminals	Max. 0.5 N•m	Max. 0.5 N•m	Max. 0.5 N•m

Standards Compliance and Certifications

Standards Compliance	Certifications
EN 60664, EN 60038	cULus Listed (File E14840, Guide NKCR, NKCR7)
UL 508	

Function and Wiring Diagrams

Bulletin 809S Wiring Diagram

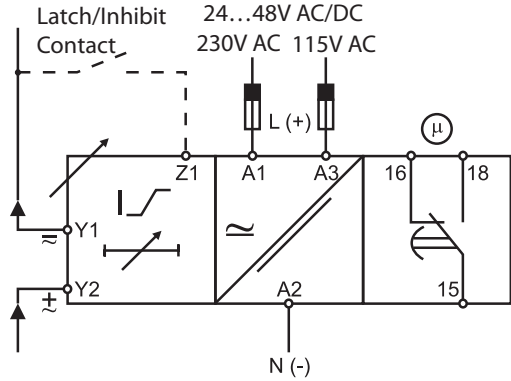

Terminals	Power Supply
A1, A2	24/48V AC/DC
	230V AC
A3, A2	115V AC

Single-Phase Current Monitoring Relays

These devices are TRMS AC/DC over- or undercurrent monitoring relays. Through the built-in shunt, it is possible to monitor loads up to 10 A AC/DC by direct measuring or through a current transformer. When monitoring current through a current transformer and the latch function is disabled, the relay operates when the measured value exceeds (or drops below) the set level for more than the set delay time. It releases when the current drops below (or exceeds) the set level or when the power supply is interrupted. With the built-in latch function, the ON position of the relay output can be maintained. The inhibit function can be used to avoid relay operation when not desired. The LEDs indicate the state of the alarm and the output relay.

Bulletin 809S Function Diagrams

Overcurrent - Normally De-energized relay

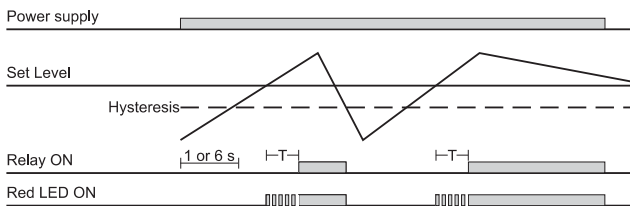

Overcurrent - Inhibit function - Normally De-energized relay

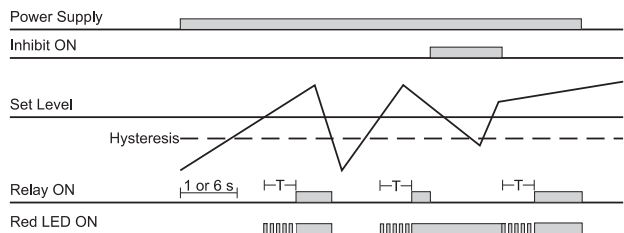

Undercurrent - Normally De-energized relay

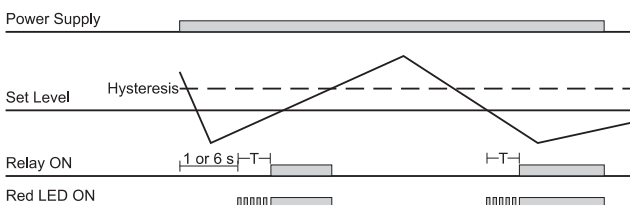

Undercurrent - Latch function - Normally De-energized relay

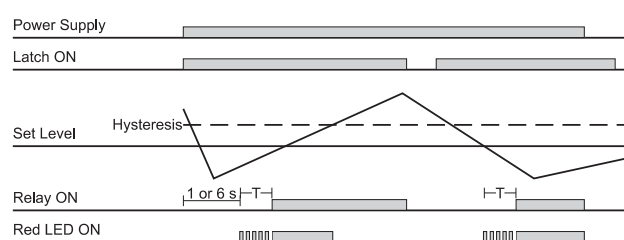

Bulletin 813S Wiring Diagram — Single-Phase

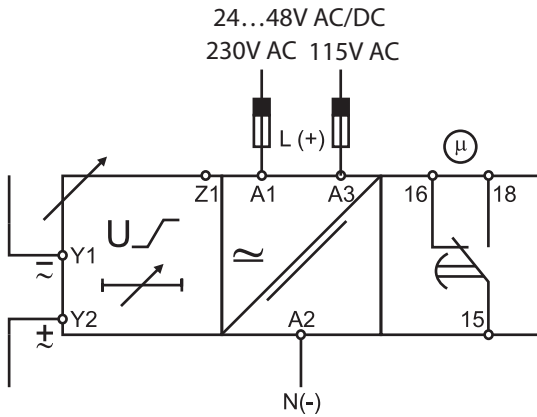

Terminals	Power Supply
A1, A2	24/48V AC/DC
	230V AC
A3, A2	115V AC

Single-Phase Voltage Monitoring Relays

These devices are TRMS AC/DC over- or undervoltage monitoring relays. When the latch function is disabled, the relay operates when the measured value exceeds (or drops below) the set level for more than the set delay time. It releases when the voltage drops below (or exceeds) the set level or when the power supply is interrupted. With the built-in latch function, the ON position of the relay output can be maintained. The inhibit function can be used to avoid relay operation when not desired. The LEDs indicate the state of the alarm and the output relay.

Bulletin 813S Function Diagrams — Single-Phase

Overvoltage - Normally De-energized relay

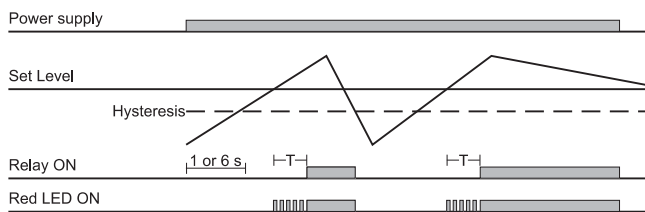

Overvoltage - Inhibit function - Normally De-energized relay

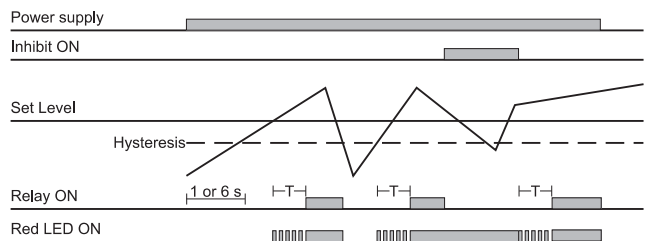

Undervoltage - Normally De-energized relay

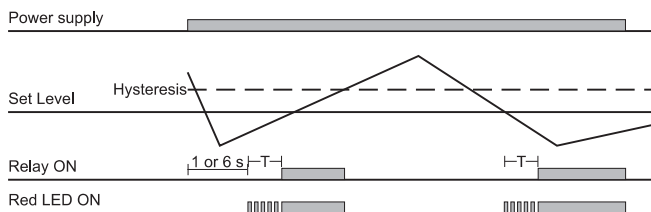

Under voltage - Latch function - Normally De-energized relay

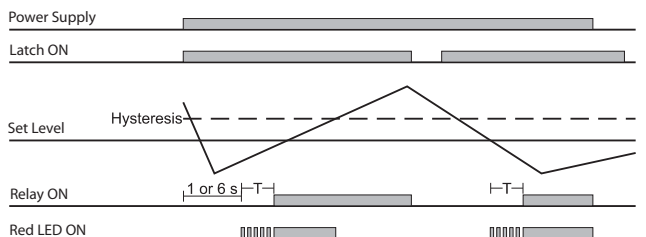

Bulletin 813S Wiring Diagram — Three-Phase

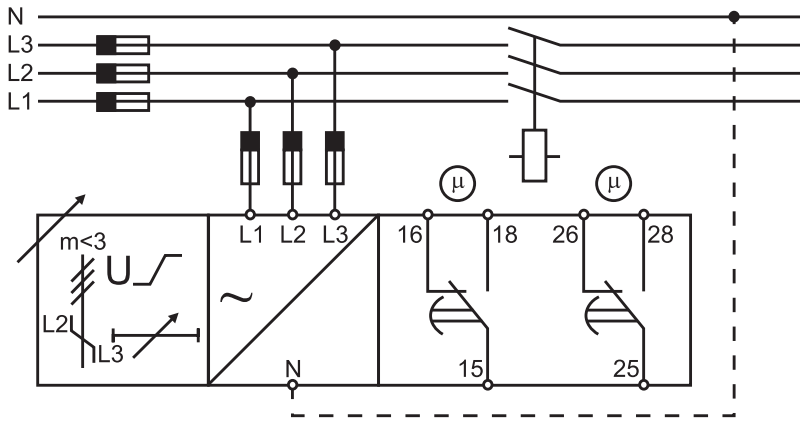

Three-Phase Voltage Monitoring Relays

These self-powered devices are TRMS three-phase over- and undervoltage, phase sequence, phase loss, and asymmetry and tolerance monitoring relays. For voltage level monitoring, if one or more phase-phase or phase-neutral voltage exceeds the upper set level or drops below the lower set level, the red LED starts flashing and the respective output relay releases after the set time period. For asymmetry and tolerance monitoring, if one or more phase-phase or phase-neutral voltage exceeds the set levels, the red LED starts flashing and the respective output relay releases after the set time period. For both functions, if the phase sequence is wrong or one phase is lost, both output relays release immediately.

Bulletin 813S Function Diagrams — Three-Phase

Asymmetry and tolerance monitoring (2 x SPDT relays)

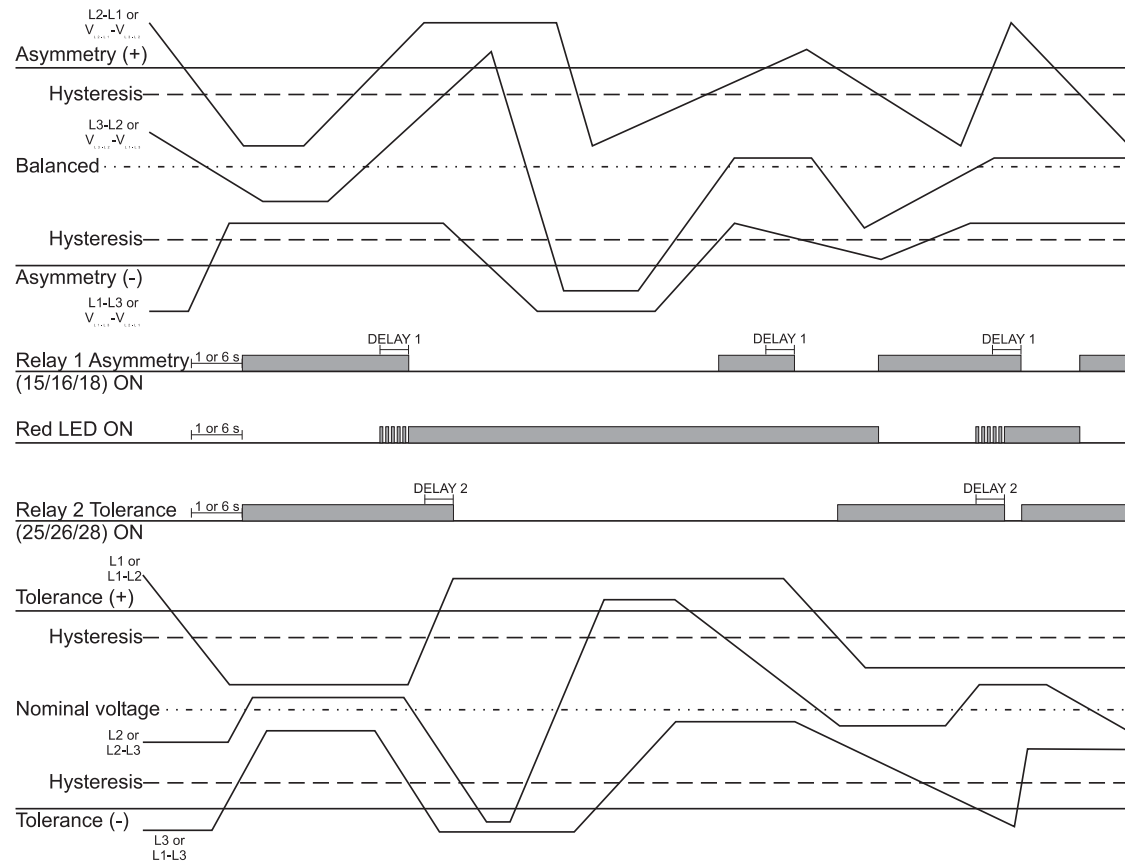

Bulletin 813S Function Diagrams — Three-Phase, Continued

Over and undervoltage monitoring (2 x SPDT relays)

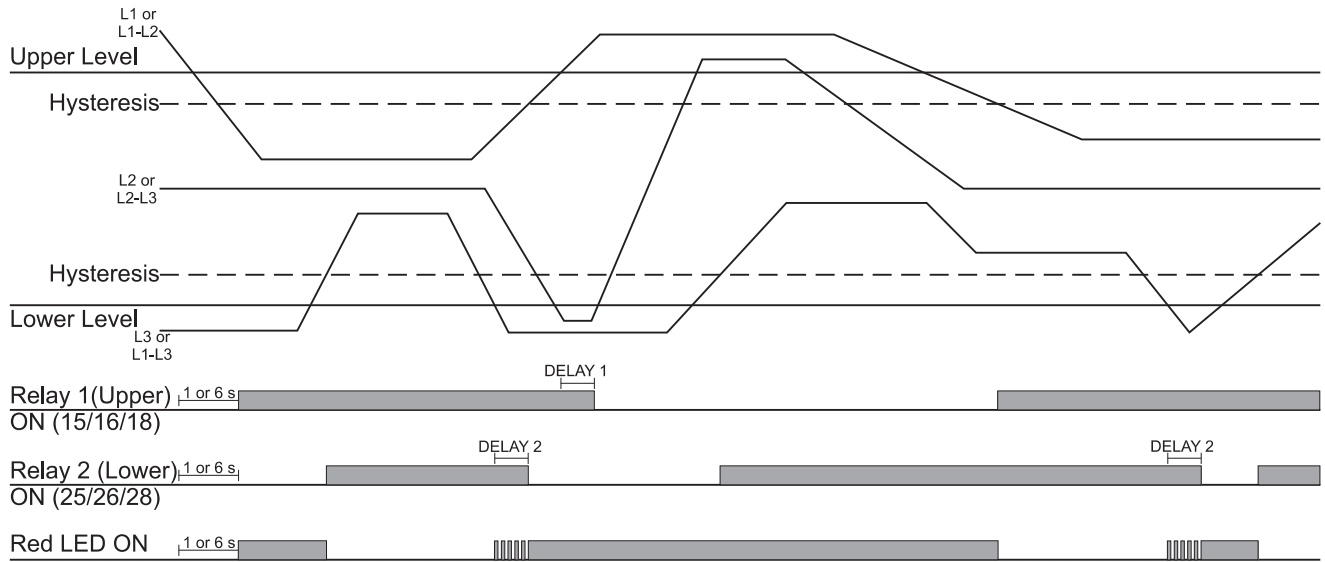

Phase sequence, total phase loss

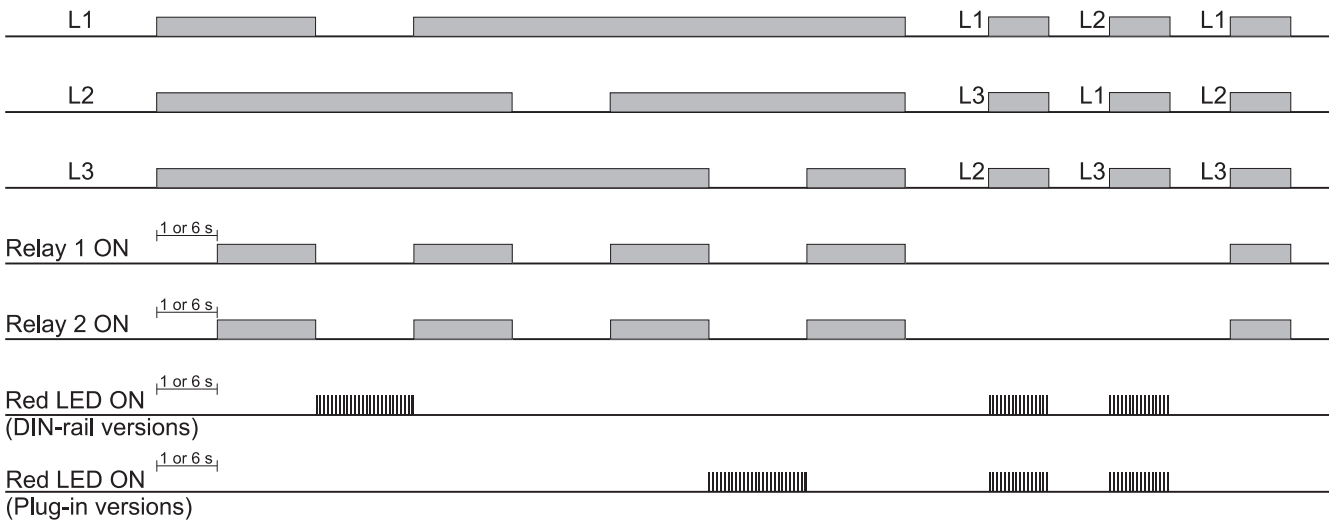

Bulletin 814S Wiring Diagram — Power (kW) Type

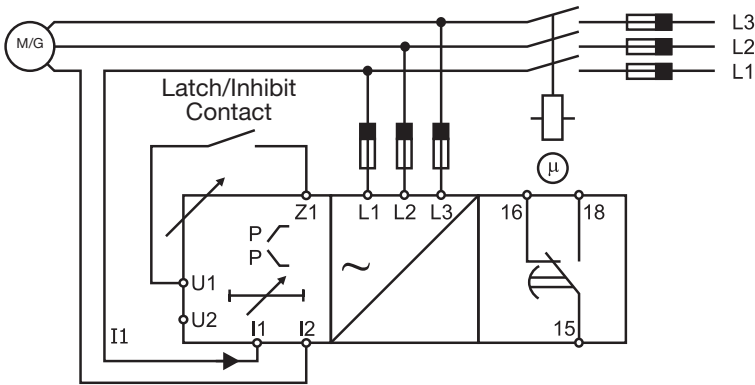

Three-Phase Active Power (kW) Monitoring Relays

These self-powered devices are TRMS active power monitoring relays for three-phase balanced systems. They can be used for monitoring the actual load of asynchronous motors and other symmetrical loads, as well as to see if the power flows in the correct direction. The monitoring relay measures the active power of a three-phase balanced system. The relay has an adjustable power ON delay in order to avoid undesired overload detection during motor start. With the built-in latch function, the ON-position of the relay output can be maintained. The inhibit function can be used to avoid relay operation when not desired. The LEDs indicate the state of the alarm and the output relay.

Bulletin 814S Function Diagrams — Power (kW) Type

Inhibit function - Normally De-energized relay

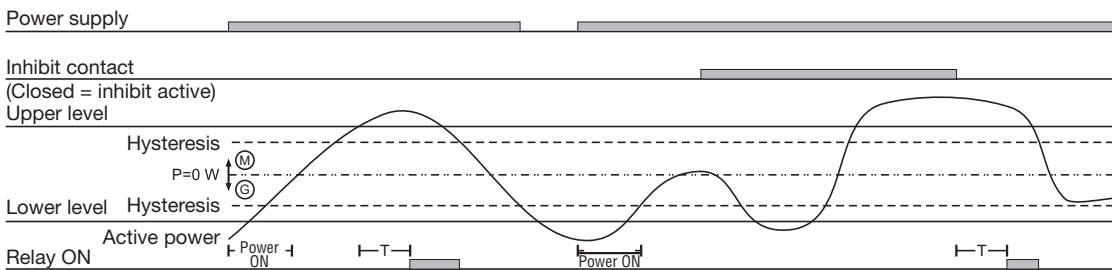

Latch function - Normally Energized relay

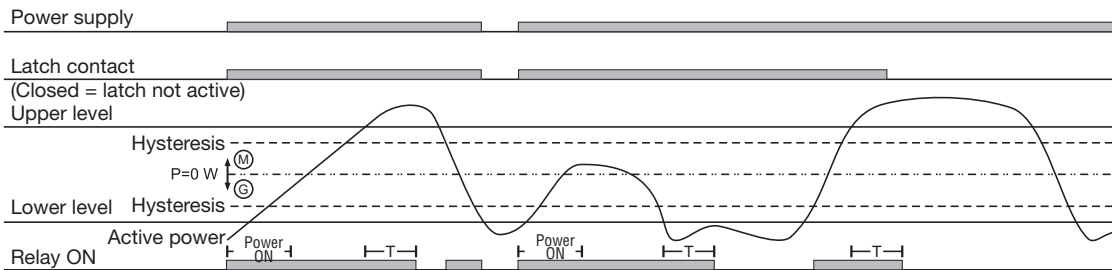

Start and stop function - Normally Energized relay

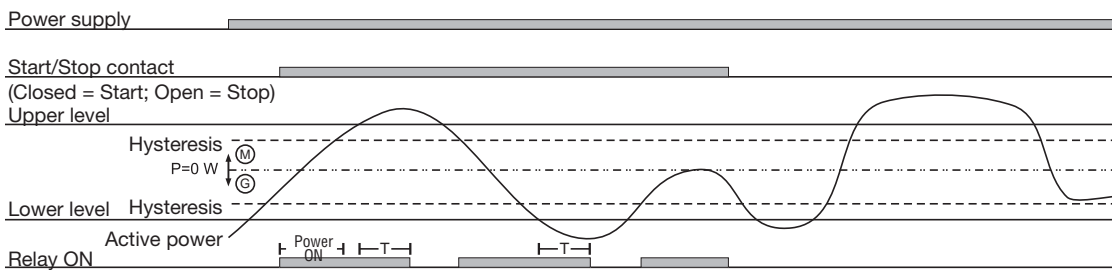

Bulletin 814S Wiring Diagram — Power Factor Type

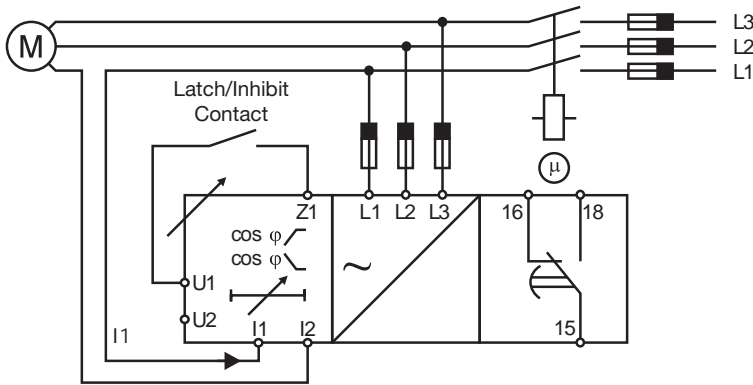

Three-Phase Power Factor Monitoring Relays

These self-powered devices are TRMS power factor monitoring relays for three-phase balanced systems. They can be used for monitoring the actual load of asynchronous motors and other symmetrical loads, where the power factor is almost proportional to the load. The relay measures the absolute value for the power factor of the system $PF = \text{Active Power} / \text{Apparent Power}$ that is for balanced system with sinus waveforms the cosine of the angle between motor current and motor voltage ($\cos \phi$). As $\cos \phi$ varies with the load of the motor, underload and overload can be indirectly detected by the monitoring relay. With the built-in latch function, the ON-position of the relay output can be maintained. The inhibit function can be used to avoid relay operation when not desired. The LEDs indicate the state of the alarm and the output relay.

Bulletin 814S Function Diagrams — Power Factor Type

Inhibit function - Normally De-energized relay

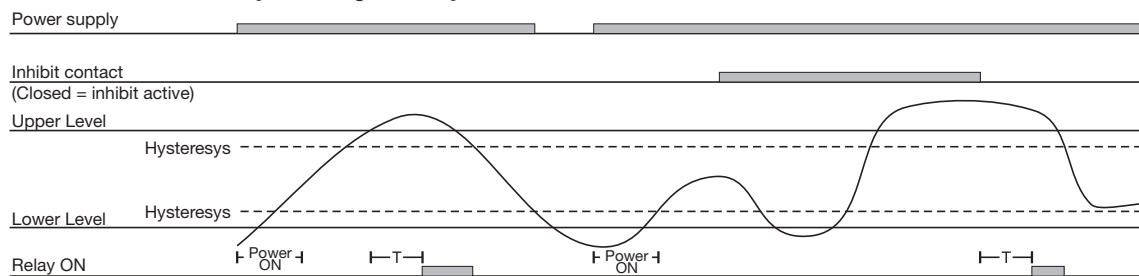

Latch function - Normally Energized relay

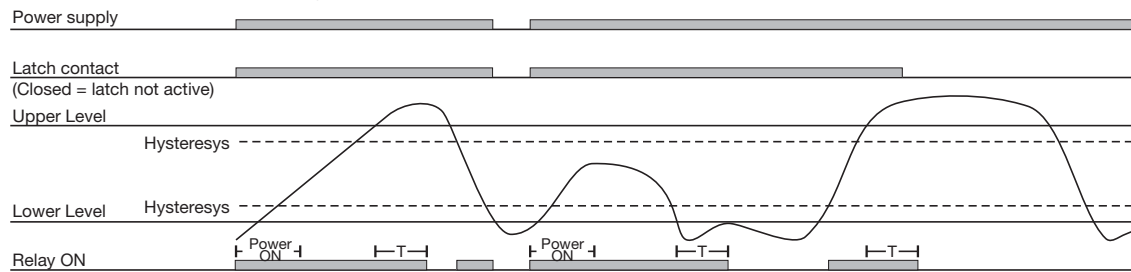

Start and stop function - Normally Energized relay

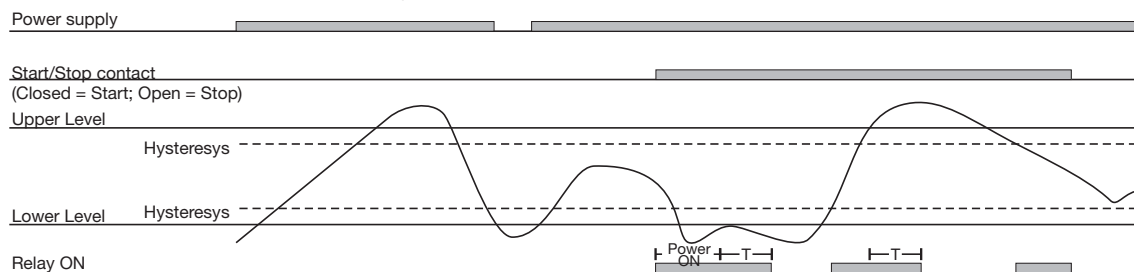

Thermistor Monitoring Relays

These devices are motor temperature monitoring relays, used to monitor the temperature of the coils of a motor with built-in PTC's. The alarm status of the relay can be reset by either an external contact or an internal button. The test button allows the simulation of the fault condition. The LED's indicate the alarm status.

Bulletin 817S Wiring Diagram

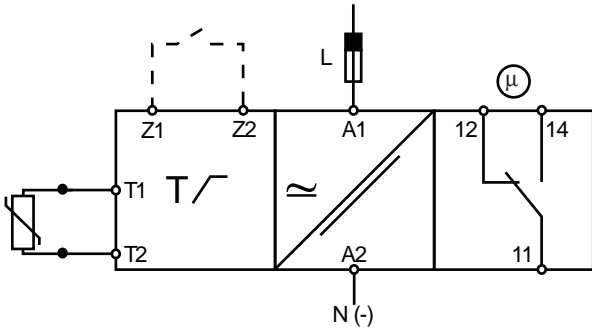

Bulletin 817S Function Diagram

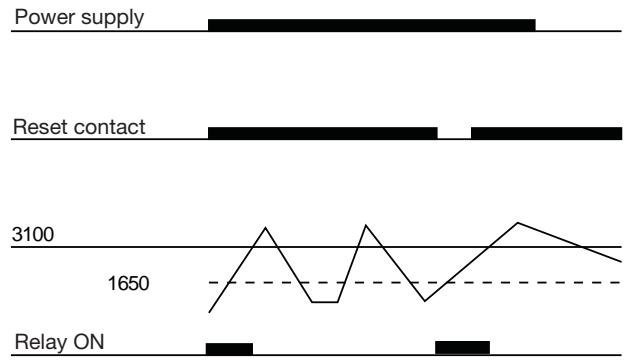

Approximate Dimensions

Dimensions shown are in millimeters (inches) Dimensions are not intended for manufacturing purposes.

Bulletin 809S, 813S Single-Phase Relays/Bulletin 817S Thermistor Relays

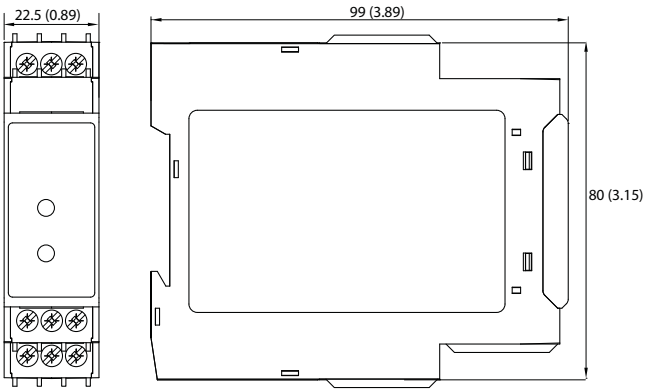

Bulletin 813S, 814S Three-Phase Relays

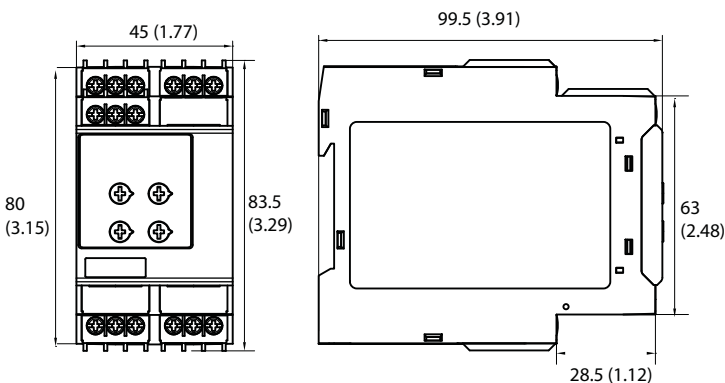

Bulletin 1409 Arcing Ground Fault Detection System

Supplemental Motor Protection Devices Specifications



Arcing Ground Fault Relay
Cat. No. 1409-DOB



Arcing Ground Fault Sensor
Cat. No. 1409-N2

The Bulletin 1409 Arcing Ground Fault Detection Systems are intended for equipment protection only. **These systems are not Ground-Fault Circuit-Interrupters for personnel protection as defined in Article 100 of the U.S. National Electric Code.**

Bulletin 1409 is available in two designs, Class I and Class II. The Class I systems are intended for use with shunt-trip circuit breakers or medium voltage controllers. These Class I systems **do not** contain a high-current inhibit circuit.

The Class II Systems are designed for use with motor starters or contactors to interrupt low-level ground faults. They incorporate a high-current inhibit circuit that guards against the controller opening when the fault current exceeds the controller interrupting capacity. Ground fault currents exceeding the interrupting rating of the controllers are designed to be cleared by the short circuit protection device (fuse or circuit breaker).

Both Class I and Class II Systems consist of two parts — a relay and a sensor. The relay contains all the detection, adjustment and output circuitry. The sensor is a special two-winding current transformer. Operation of the ground fault detection system is indicated by the relay toggle.

Specifications

Response Time	50 ms nominal plus the controller drop-out time
Supply Voltage	120V AC, 60 Hz
Power Input	3 VA
Temperature Range	The operating ambient temperature range for the sensor is $-40 \dots +85^{\circ}\text{C}$ ($-40 \dots +184^{\circ}\text{F}$) and for the relay is $0 \dots +65^{\circ}\text{C}$ ($32 \dots 149^{\circ}\text{F}$)
Output Contact Rating	Make 30 A; Break 3 A; Continuous carrying current 5 A at 120V

Standards Compliance and Certifications

Standards Compliance	Certifications
CSA C22.2, No. 144	CSA Certified (LR49901)
UL 1053	UL Listed (File E53935, Guide KDAX)

Typical Wiring Diagrams

See Applicable Codes and Laws.

Figure 1 - Class II with High Current Inhibit Circuit (1)

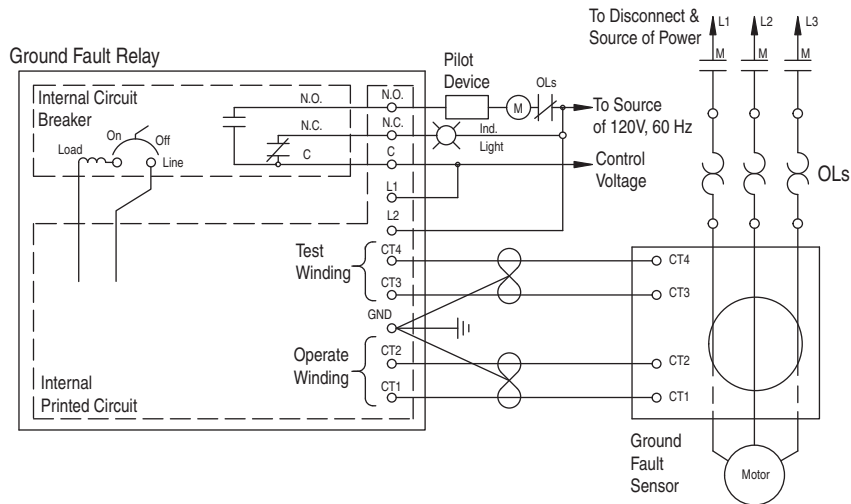
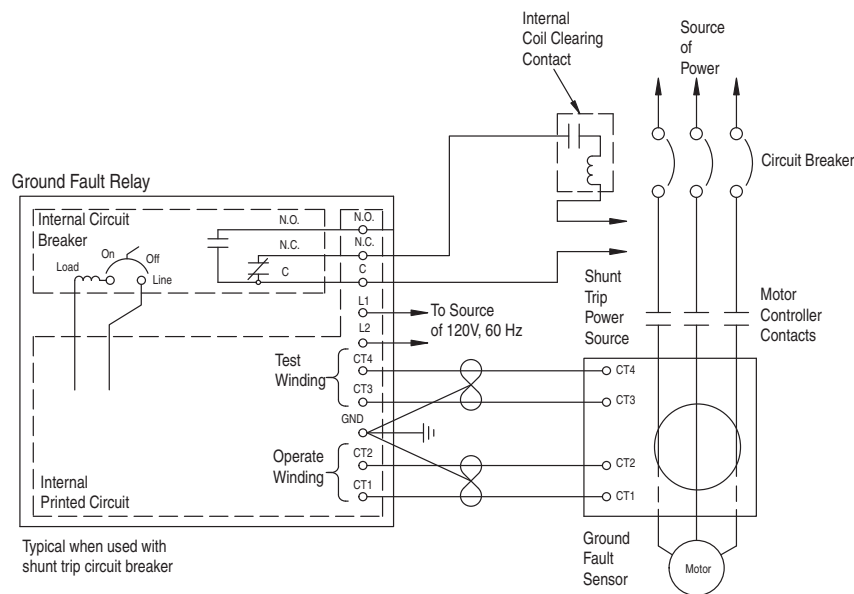

Figure 2 - Class II with High Current Inhibit Circuit (1)



(1) Wiring diagrams are shown in the tripped condition.

Approximate Dimensions

Dimensions are shown in millimeters (inches). Dimensions are not intended to be used for manufacturing purposes.

Figure 3 - Arcing Ground Fault Relay

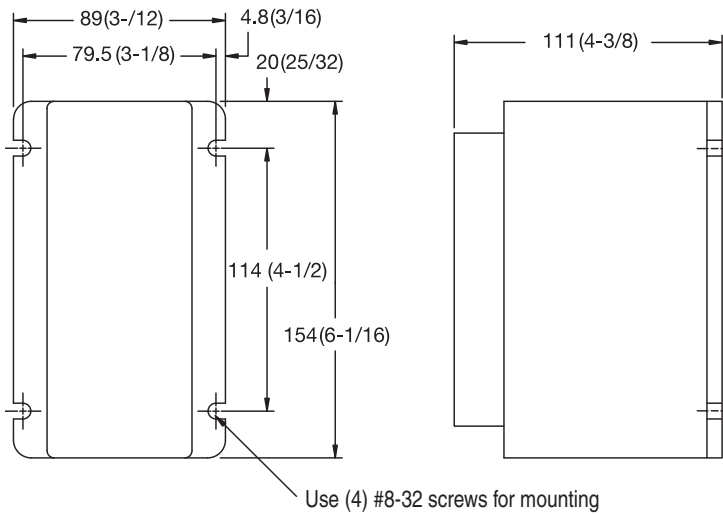
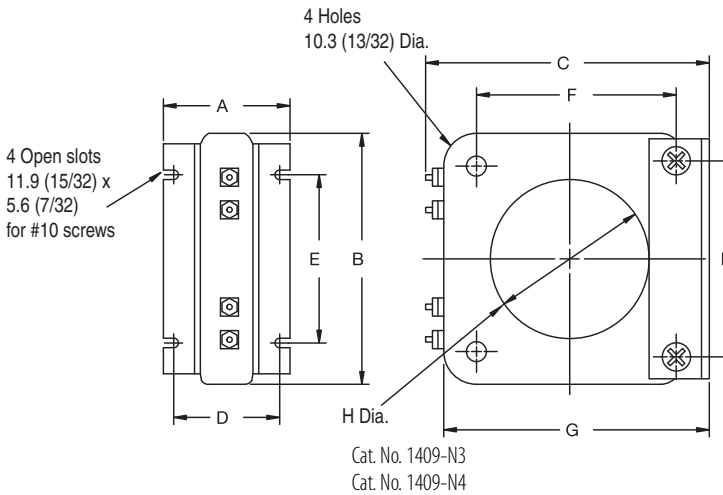
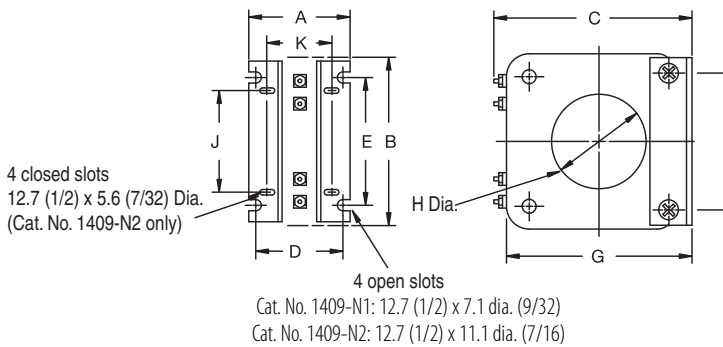

Figure 4 - Arcing Ground Fault Sensors



Cat. No.	A	B	C	D	E	F	G	H	J	K
1409-N1	92.6 (3-21/32)	88.9 (3-1/2)	104 (4-3/32)	74 (2-15/16)	67.3 (2-21/32)	56.4 (2-7/32)	92.9 (3-21/32)	39.6 (1-9/16)	—	—
1409-N2	91.4 (3-19/32)	115.8 (4-9/16)	131.8 (5-3/16)	77 (3-1/32)	88.9 (3-1/2)	88.9 (3-1/2)	120.6 (4-3/4)	63.5 (2-1/2)	69.8 (2-3/4)	54.9 (2-5/32)
1409-N3	73.2 (2-7/8)	144 (5-11/16)	157.2 (6-3/16)	54.9 (2-5/32)	96.8 (3-13/16)	119.4 (4-23/32)	146.1 (5-3/4)	82.6 (3-1/4)	—	—
1409-N4	77.2 (3-1/32)	169.9 (6-11/16)	182.6 (7-3/16)	59.5 (2-11/32)	123.7 (4-7/8)	138.2 (5-7/16)	171.5 (6-3/4)	108 (4-1/4)	—	—

Bulletin 1410 Motor Winding Heater

Supplemental Motor Protection Devices Specifications

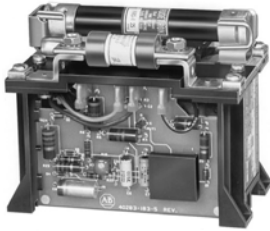

Motor Winding Heater

Bulletin 1410 Motor Winding Heater is intended for use with 3-phase AC motors to guard against damage caused by condensation build-up on motor windings, which can occur in high-humidity environments during motor off times. **This device is not intended to be used to dry out damp motors.**

Bulletin 1410 Motor Winding Heater is designed for used with 3-phase AC squirrel-cage motors controlled by automatic full-voltage starters. For applications involving reduced-voltage starters, multi-speed starters, synchronous motors, or the used of power factor correction capacitors, consult your local Rockwell Automation sales office or Allen-Bradley distributor.

Specifications

Output Voltage Regulation	Voltage applied to motor winding will vary $\pm 5\%$ maximum for line voltage variations of $+10\%$, -15% .
Ambient Temperature Range	Operating, $0 \dots 50^\circ\text{C}$ ($32 \dots 122^\circ\text{F}$) Storage, $-25 \dots +85^\circ\text{C}$ ($-13 \dots +184^\circ\text{F}$)
Additional SCR Protection	Metal oxide varistor protects against voltage surges. RC snubber circuit limits rate of change of circuit voltage.
True RMS Output Current	Approximately 15% of full load current.
Power Delivered to the Motor	Approximately 1...3 W/Hp.

Standards Compliance and Certifications

Standards Compliance	Certifications
CSA C22.2, No. 144	CSA Certified (LR1234)
UL 508	UL Listed (File E56639, Guide NMTR)

Connection Diagram

See Applicable Codes and Laws.

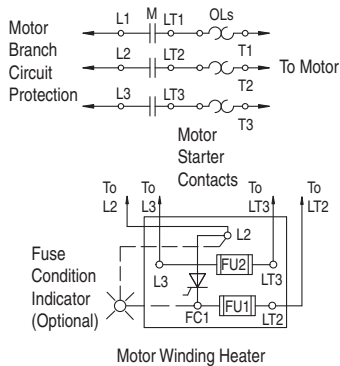

Approximate Dimensions

Dimensions are shown in millimeters (inches). Dimensions are not intended to be used for manufacturing purposes.

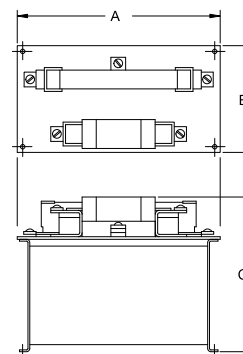

Cat. No.	A	B	C
1410-E0A47 1410-E0B50 1410-E0C50	146.1 (5-3/4)	88.9 (3-1/2)	114.3 (4-1/2)
1410-FOA50 1410-FOB54 1410-FOC54	204.8 (8-1/16)	108 (4-1/4)	177.8 (7)
1410-G0A54 1410-G0B59 1410-G0C59	238.1 (9-3/8)	146.1 (5-3/4)	206.4 (8-1/8)
1410-H0A57 1410-H0B62 1410-H0C62	279.4 (11)	244.5 (9-5/8)	207.2 (8-5/32)

Important User Information

Read this document and the documents listed in the additional resources section about installation, configuration, and operation of this equipment before you install, configure, operate, or maintain this product. Users are required to familiarize themselves with installation and wiring instructions in addition to requirements of all applicable codes, laws, and standards.

Activities including installation, adjustments, putting into service, use, assembly, disassembly, and maintenance are required to be carried out by suitably trained personnel in accordance with applicable code of practice.

If this equipment is used in a manner not specified by the manufacturer, the protection provided by the equipment may be impaired.

In no event will Rockwell Automation, Inc. be responsible or liable for indirect or consequential damages resulting from the use or application of this equipment.

The examples and diagrams in this manual are included solely for illustrative purposes. Because of the many variables and requirements associated with any particular installation, Rockwell Automation, Inc. cannot assume responsibility or liability for actual use based on the examples and diagrams.

No patent liability is assumed by Rockwell Automation, Inc. with respect to use of information, circuits, equipment, or software described in this manual.

Reproduction of the contents of this manual, in whole or in part, without written permission of Rockwell Automation, Inc., is prohibited.

Documentation Feedback

Your comments will help us serve your documentation needs better. If you have any suggestions on how to improve this document, complete this form, publication [RA-DU002](#), available at <http://www.rockwellautomation.com/literature/>.

Allen-Bradley, Rockwell Software, Rockwell Automation, and LISTEN. THINK. SOLVE are trademarks of Rockwell Automation, Inc.
Trademarks not belonging to Rockwell Automation are property of their respective companies.

Rockwell Otomasyon Ticaret A.Ş., Kar Plaza İş Merkezi E Blok Kat:6 34752 İçerenköy, İstanbul, Tel: +90 (216) 5698400

www.rockwellautomation.com

Power, Control and Information Solutions Headquarters

Americas: Rockwell Automation, 1201 South Second Street, Milwaukee, WI 53204-2496 USA, Tel: (1) 414.382.2000, Fax: (1) 414.382.4444

Europe/Middle East/Africa: Rockwell Automation NV, Pegasus Park, De Kleetlaan 12a, 1831 Diegem, Belgium, Tel: (32) 2 663 0600, Fax: (32) 2 663 0640

Asia Pacific: Rockwell Automation, Level 14, Core F, Cyberport 3, 100 Cyberport Road, Hong Kong, Tel: (852) 2887 4788, Fax: (852) 2508 1846

Publication 8095-TD001B-EN-P - December 2015

Supersedes publication 8095-TD001A-EN-PAugust 2014

Copyright © 2015 Rockwell Automation, Inc. All rights reserved. Printed in the U.S.A.